

OPERATION MANUAL

STEREO TRIGGERSCOPE

MODEL 5502

KIKUSUI ELECTRONICS CORPORATION

98.11.66

704402

Power Requirements of this Product

Power requirements of this product have been changed and the relevant sections of the Operation Manual should be revised accordingly.

(Revision should be applied to items indicated by a check mark)

Input voltage

The input voltage of this product is _____ VAC,
and the voltage range is _____ to _____ VAC. Use the product within this range only.

Input fuse

The rating of this product's input fuse is _____ A, _____ VAC, and _____.

WARNING

- To avoid electrical shock, always disconnect the AC power cable or turn off the switch on the switchboard before attempting to check or replace the fuse.
- Use a fuse element having a shape, rating, and characteristics suitable for this product. The use of a fuse with a different rating or one that short circuits the fuse holder may result in fire, electric shock, or irreparable damage.

AC power cable

The product is provided with AC power cables described below. If the cable has no power plug, attach a power plug or crimp-style terminals to the cable in accordance with the wire colors specified in the drawing.

WARNING

- The attachment of a power plug or crimp-style terminals must be carried out by qualified personnel.



TABLE OF CONTENTS

	<u>PAGE</u>
1. GENERAL	1
1.1 Description	1
1.2 Features	1
2. SPECIFICATIONS	3
3. OPERATING INSTRUCTIONS	10
3.1 Explanation of Front Panel	10
3.2 Explanation of Rear Panel	15
3.3 Explanation of Bottom Panel	15
3.4 Precautions in Operation	18
3.5 Line Voltage Conversion	19
4. OPERATING PROCEDURE	21
4.1 Preliminary Procedure	21
4.2 Dual-trace Operation	23
4.3 X-Y Operation	25
5. METHODS OF MEASUREMENTS	27
5.1 Connection Method of Input Signal	27
5.2 Voltage Measurement	31
5.3 Current Measurement	33
5.4 Time Measurement	33
5.5 Frequency Measurement	34
5.6 Measurement of Phase Difference	36
5.7 Measurement of Pulse Waveform Characteristics ...	43

	<u>PAGE</u>
6. CALIBRATION	46
6.1 General	46
6.2 Check and Adjustment of DC Power Supply	46
6.3 Adjustment of Vertical Axis	51
6.4 Adjustment for Horizontal Dual-trace Operation	54
6.5 Adjustment of Time Base	57
6.6 Adjustment of X-axis	58
6.7 Calibration of Probe	59
7. Block Diagram	

1. GENERAL

1.1 Description

Kikusui Model 5502 Stereo Triggerscope is a trigger-synchronized dual-trace portable oscilloscope with a high-brightness cathode-ray tube of 133 mm (5.24 in.) diameter. Its sensitivity is 10 mV/DIV, bandwidth 5 MHz, and maximum sweep speed 1 μ sec/DIV. Its operation is selectable between vertical dual-channel mode and horizontal dual-channel mode with its mode selector switch. It can be used for research and development of various electronic devices as well as for production and maintenance service.

1.2 Features

- o Front frame made of aluminium diecast:

To provide a neat external view and a sufficient mechanical strength for maintenance service, the front frame is made of aluminium diecast.

- o Dual-channel mode selector switch incorporated:

The 5502 is incorporated with a mode selector switch for selection between vertical dual-channel operation and horizontal dual-channel operation, providing an another advantageous feature in observation of various types of waveforms.

- o High-brightness CRT:

The 5502 employs a CRT of an excellent beam transmission factor, providing a sufficient trace brightness even at the highest sweep speed.

794405

- o Stable acceleration voltage:

The acceleration voltage of the 5502 is very stable against line voltage variation, as this high voltage is regulated with a unique control circuit.

- o Rotation coil for trace leveling:

The 5502 employs a rotation coil which enables you to adjust (rotate) the base line for leveling when it has become slanted by terrestrial magnetism. Adjustment can be done at the front panel.

- o Automatic CHOP/ALT switching:

The operating mode is automatically switched between CHOP mode and ALT mode in conformity with the sweep speed (linked to the TIME/DIV switch), thereby preventing troublesome manual switching between the two modes when in the dual-channel operation.

- o Wider triggering frequency range:

The 5502 has a wide triggering frequency range of 10 Hz - 5 MHz, enabling low frequency signal waveform observation and phase measurement with a trigger frequency of down to 10 Hz.

- o X-Y mode is switched by one-touch action:

Simply by switching the operation of the vertical axis, the oscilloscope can be converted into an X-Y scope with CHL input for X-axis and CHR input for Y-axis.

2. SPECIFICATIONS

Vertical Axis

Item	Specification	Remarks
Sensitivity ranges	10 mV/DIV - 1 V/DIV	1-10 sequency, 4-ranges including GND
Sensitivity accuracy	Better than $\pm 5\%$ of panel-indicated value.	VARIABLE knob is set in CAL position
Continuously-variable sensitivity adjustment	10 times or over	Covers between ranges with VARIABLE knob.
Frequency response	DC: DC - 5 MHz, within -3 dB AC: 2 Hz - 5 MHz, within -3 dB	50 kHz, 8 DIV reference.
Rise time	Approx. 70 nsec	
Input impedance	1 M Ω $\pm 2\%$, approx. 30 pF ± 2 pF	Parallel. Probe can be used.
Input terminals	BNC receptacles	
Maximum allowable input voltage	400 Vp-p, for 1 minute.	DC + AC peak, frequency not higher than 1 kHz.
Input coupling selection	AC, DC	
DC balance	Less than ± 0.5 DIV	

794407

Item	Specification		Remarks
Operation modes of vertical axis	CHL	Single-channel mode	
	CHR	Single-channel mode	
	STEREO	CHOP mode (10 msec/DIV - 1 msec/DIV)	When trigger source is CHL or CHL + CHR
		ALT mode (100 μ sec/DIV - 1 μ sec/DIV)	When trigger source is NORM, operation is ALT mode for all TIME/DIV ranges.
	H	Horizontal dual-channel operation	
V	Vertical dual-channel operation		
Chop frequency	Approx. 100 kHz		
Overshoots	Not higher than 3%		100 kHz square wave, 4 DIV
Isolation between channels	500 : 1 or better		100 kHz, 8 DIV
Linearity	When a signal displayed for 4 DIV in CRT screen center is vertically shifted for the full screen range, vertical amplitude change is within ± 0.2 DIV.		At frequency not higher than 100 kHz. Including linearity of CRT.

o Trigger

Item	Specification		Remarks
Trigger signal	CHL	Triggered with CHL signal alone.	
	CHL + CHR	Triggered with the sum of the signals of CHL and CHR.	CHL and CHR signals must be of the same frequency.
	NORM	Triggered with CHL and CHR signals.	
	EXT	Triggered with external signal.	
Sensitivity	INT	10 Hz - 5 MHz, 0.5 DIV or over	In terms of displayed signal amplitude on the CRT.
	EXT	10 Hz - 5 MHz, 0.5 Vp-p or over	
Trigger system	AUTO trigger sweep		When no signal is applied, the sweep occurs in FREE RUN mode. For input signal of 10 Hz or higher, the above trigger sensitivity specification is met.
Polarity (SLOPE)	"+" only		
Coupling	AC		

Item	Specification	Remarks
EXT trigger input impedance	Approx. 1 M Ω , 50 pF or less	Parallel
Maximum allowable input impedance	100 Vp-p	DC + AC peak. Frequency not higher than 1 kHz.
External input terminals	BNC receptacles	

Horizontal Axis

Item	Specification	Remarks
Sweep time	1 μ sec - 10 msec/DIV	1, 10, step 5 ranges
Continuously variable range of sweep time	10 times or over	Covers between ranges with VARIABLE knob.
Sweep time accuracy	Better than $\pm 5\%$ of panel indicated value VARIABLE knob set in CAL position	
Sweep directions	MODE V	From left end to right end on CRT screen for both CHL and CHR
	MODE H	From left end to center for CHL and from right end to center for CHR From left end to center for CHL and from center to right end for CHR also are possible by changing internal connections.

Item	Specification	Remarks
X-Y mode	CHL for X (horizontal) CHR for Y (vertical)	
Sensitivity	The same spec's as CHL of the vertical axis.	
Frequency response	DC: DC - 1 MHz, within -3 dB AC: 2 Hz - 1 MHz, within -3 dB	50 kHz, 10 DIV reference
Input impedance	The same spec's as CHL of the vertical axis	
Maximum allowable input voltage	The same spec's as CHL of the vertical axis	
X-Y phase difference	Within 3° at 50 kHz	

Calibration Voltage

Item	Specification	Remarks
Waveform	Square wave, positive going	
Output voltage	1 Vp-p, ±3%	
Frequency	1 kHz ±25%	
Duty ratio	45 : 55 - 55 : 45	
Output terminal	Chip terminal	

794411

Cathode-ray Tube

Item	Specification	Remarks
Shape	Round, 133 mm	(5.24 in.)
Fluorescent screen	B31	Green
Acceleration voltage	Approx. 1600 V	Regulated
Area (graticule)	8 × 10 DIV	1 DIV = 9.5 mm (0.37 in.)
Unblanking	AC-coupling	at G1 of the CRT

Power Requirements

Item	Specification	Remarks
AC line voltage	100, 110, 120, 220, 230, or 240 V. (Within ±10% of each nominal voltage)	Selectable with connector and pins of voltage selector board
Frequency	50 - 60 Hz	
Power consumption	Approx. 20 VA	

Mechanical Specification

Item	Specification	Remarks
Overall dimensions	244 W × 184 H × 370 D mm (9.61 W × 7.24 H × 14.57 D in.) 250 W × 210 H × 425 D mm (9.84 W × 8.27 H × 16.73 D in.)	Maximum dimensions
Weight	Approx. 7 kg (15.4 lbs)	

Ambient Conditions

Item	Specification	Remarks
Specification conditions	5°C - 35°C (41°F - 95°F), 85% or less	Conditions for meeting specification performances
Operating conditions	0°C - 40°C (32°F - 104°F), 90% or less	Conditions for instrument operation



COMPOSITION





A complete set of the instrument is composed of the following items:





Triggerscope main unit	1
Accessories	
Type 942A Terminal Adaptors	2
Operation manual	1
Options	
960 BNC Type Probe (10:1, 1:1)	

3. OPERATING INSTRUCTIONS

3.1 Explanation of Front Panel (See Fig. 1)

No.	Panel mark	Description
①	POWER ON-OFF	AC mains power ON-OFF switch.
②	INTEN	Trace intensity control. Trace becomes brighter as this knob is turned clockwise.
③		Indicates ON/OFF state of instrument power.
④	TRACE ROTATION	Semi-fixed resistor for level (horizontal inclination) adjustment of base line which may be inclined by terrestrial magnetism, etc. Adjust with a fine screwdriver.
⑤	FOCUS	So adjust this knob that the trace displayed on the screen becomes sharpest.
⑥	CALIB 0.5 Vp-p	Output terminal which provides a calibration voltage used for probe calibration. The calibration voltage is 0.5 Vp-p ($\pm 5\%$), positive-going square wave of approx. 1 kHz.
⑦		Ground terminal
⑧	POSITION 	For vertical positioning of CHR (or Y-axis). The trace moves upward as this knob is turned clockwise, and vice versa.

No.	Panel mark	Description
⑨ ⑩ ⑪ ⑫	MODE CHL ⑫ CHR ⑪ (BOTH IN) STEREO X-Y ⑩ H  V  ⑨	Pushbutton switches for selecting operating modes of CHL and CHR amplifiers. CHL: CHL vertical amplifier alone operates, as a single-channel oscilloscope. CHR: CHR vertical amplifier alone operates, as a single-channel oscilloscope. STEREO: When both CHL and CHR buttons are pressed at the same time, CHL and CHR vertical amplifiers operate in CHOP or ALT mode and the instrument operates as a dual-channel oscilloscope. Switching between CHOP and ALT modes is automatically done being linked to TIME/DIV switch. X-Y: X-Y operation with CHL as X-axis (horizontal) and CHR as Y-axis (vertical). H  : Horizontal dual-trace oscilloscope with CHL and CHR signals displayed to left and right in horizontal direction. V  : Regular dual-trace oscilloscope
⑬	POSITION 	For vertical positioning of CHR. The function is the same with that of No. ⑧.

No.	Panel mark	Description
⑭ ⑮	VOLTS/DIV	<p>Rotary switch for sensitivity selection of CHL (or X-axis) and CHR (or Y-axis) channels covering four ranges of 10 mV/DIV to 1 V/DIV and including GND.</p> <p>Used to obtain appropriate deflection amplitudes on CRT screen. When set at GND, input circuit is made open and amplifier input is grounded, providing a convenient means of checking the base line level of trace.</p>
⑰ ⑱	VARIABLE	<p>Continuously-variable adjustment of vertical sensitivity of CHL (or X-axis) and CHR (or Y-axis), covering between ranges selected by VOLTS/DIV switch (⑭ or ⑮).</p> <p>(At the CAL position, sensitivity is calibrated to the value indicated by VOLTS/DIV switch.)</p>
⑲ ⑳	CHL (X) CHR (Y)	<p>Input terminals for CHL (X-axis) and CHR (Y-axis). When in X-Y operation, CHL is used as X-axis (horizontal axis). The signal can be applied with 959A BNC probe or type 942A terminal adaptor.</p>
⑳ ㉑	 AC  DC	<p>Pushbutton switch for selection of input coupling of vertical amplifier. The popped up state () is for AC coupling and the depressed state () for DC coupling.</p>

794416

No.	Panel mark	Description
②②	EXT TRIG IN	Input terminal for external trigger signal. When the TRIGGERING switch ②⑥ is set in the EXT state, the sweep is triggered by the signal applied to this terminal.
②③	TIME/DIV	Horizontal sweep time selector switch for 10 msec/DIV - 1 μsec/DIV in 5 ranges.
②④	VARIABLE	Continuously-variable adjustment of sweep time, covering between ranges selected by TIME/DIV switch ②③. (When this knob is set in the CAL position, the sweep time is calibrated at the value indicated by the TIME/DIV switch.)
②⑤	LEVEL - ← 0 → +	Trigger level adjustment for displaying stationary waveform. The trigger level rises as this knob is turned toward → + and it falls as the knob is turned toward - ←.
②⑥ ②⑦ ②⑧	TRIGGERING (BOTH IN) <div style="display: flex; justify-content: space-around; align-items: center;"> <div style="text-align: center;"> CHL + CHR ┌───┐ CHL NORM □ □ ②⑧ ②⑦ </div> <div style="text-align: center;"> INT EXT □ □ ②⑥ </div> </div>	Triggering switch circuit consisting of trigger source. <div style="margin-left: 20px;"> <p><input checked="" type="checkbox"/> INT: For internal trigger source. Triggering is done with signal selected by switch ②⑦ or ②⑧.</p> <p><input type="checkbox"/> EXT: Trigger source is external (the signal applied through TRIG IN terminal ②② is used as the trigger signal).</p> </div>

794417

No.	Panel mark	Description
		<p> <input type="checkbox"/> CHL: Signal of CHL is used as trigger source signal. </p> <p> <input type="checkbox"/> NORM: Signals of CHL and CHR are used as trigger source signals. </p> <p> (BOTH IN) </p> <p> <input type="checkbox"/> CHL + CHR: Sum of signals of CHL and CHR is used as trigger source signal. Signals of CHL and CHR must be of the same repetition frequency and phase difference within 180°. </p>
<p>②9</p>	<p>↔</p> <p>POSITION</p>	<p>Horizontal positioning knob. The displayed waveform moves rightward as this knob is turned clockwise, and vice versa.</p>

3.2 Explanation of Rear Panel (See Fig. 2)

No.	Panel mark	Description
③④	—	AC power cord of the oscilloscope
③⑤	—	Studs for using the oscilloscope in a vertical attitude. Also used as AC power cord take-up posts.
③⑥	(FUSE)	Fuse holder. Fuse rating is 0.5 A for 100 V system AC line or 0.3 A for 200 V system AC line. For replacing the fuse, remove the cap by turning it counterclockwise.

3.3 Explanation of Bottom Panel (See Fig. 3)

No.	Panel mark	Description
③⑦	ASTIG	Semi-fixed resistor for astigmatism control So adjust this control in conjunction with the FOCUS control that the trace is made sharpest.
③⑧	—	Studs which are used also for fixing the stand.
③⑨	—	Stand for setting the oscilloscope in a slanted attitude for ease of observation. Do not use this stand when oscilloscope camera and adaptor are used.

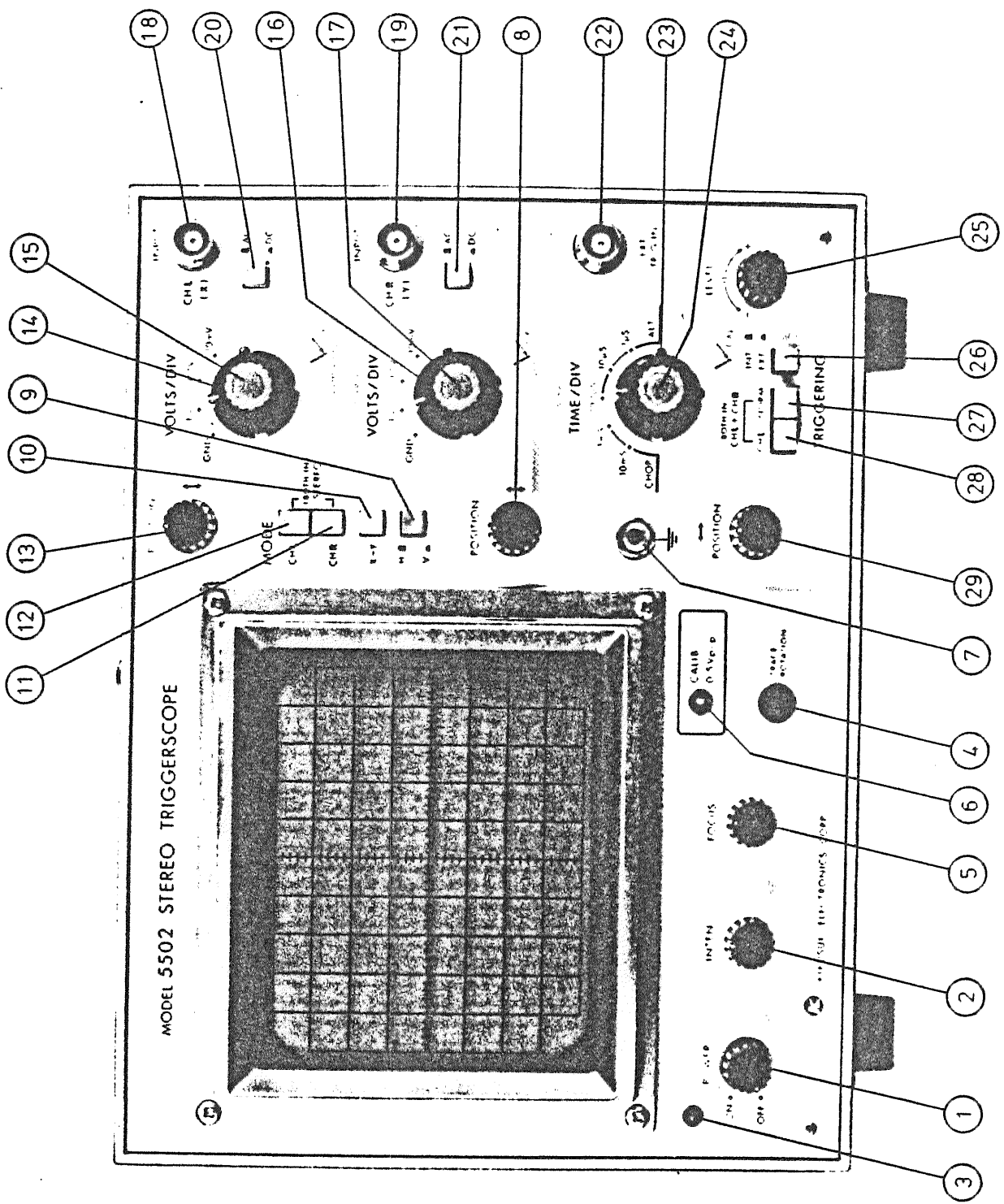

Fig. 1

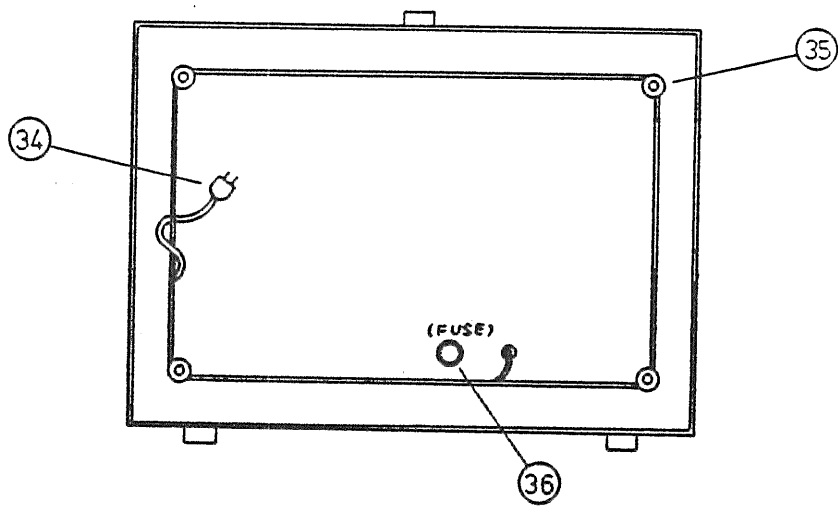

Fig. 2

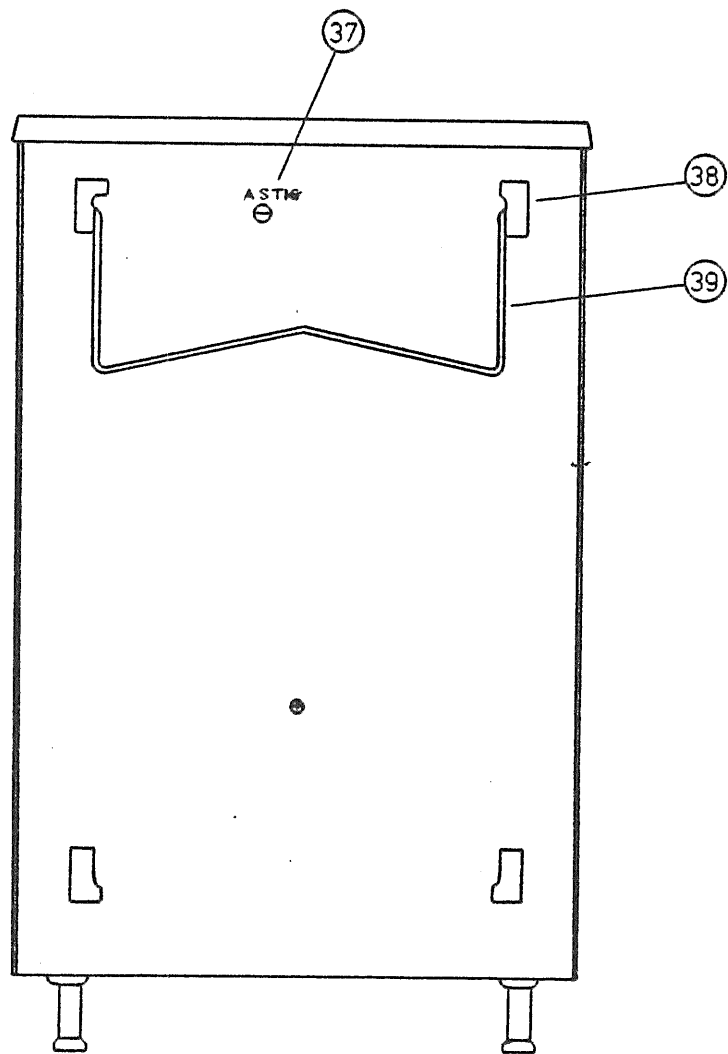

Fig. 3

794421

3.4 Precautions in Operation

- o Line voltage:

The oscilloscope is set for operation on a 100 V $\pm 10\%$ AC line voltage. To operate the oscilloscope on other AC line voltage, it must be modified as explained in Para. 3.5 "AC Line Voltage Conversion." Note that the oscilloscope will not operate properly or may be damaged if it is operated on a wrong AC line voltage.

- o Ambient temperature:

The ambient temperature range for normal operation of the oscilloscope is 5°C - 35°C (41°F - 95°F).

- o Environments:

The oscilloscope must not be operated or stored in high temperature, high humidity atmosphere for a long period since such will cause troubles or shorten the instrument life.

If the oscilloscope is operated in a strong electric or magnetic field, the displayed waveform may be distorted.

- o Intensity of CRT beam:

Do not make the CRT image excessively bright and do not leave the spot stationary for a long period, lest the CRT screen should be "burnt" shortening its life.

- o Allowable voltages of input terminals:

The maximum allowable voltages of input terminals and probe (option) are as shown in the below table. Note that the circuit may be damaged if a voltage larger than the allowable maximum is applied.

794422

Terminal	Allowable maximum input voltage
Vertical input terminal	400 Vp-p (DC + ACp, within 1 minute)
Probe (960 BNC) (option)	600 Vp-p (DC + ACp, within 1 minute)
EXT TRIG IN terminal	100 Vp-p (DC + ACp)
Repetition frequency of AC: Not higher than 1 kHz	

3.5 Line Voltage Conversion

As a general rule the 5502 Oscilloscope is shipped being set for use on a 100 V AC line power. To operate the instrument on other AC line voltage, its AC power input circuit (power connector B, tap, and fuse) must be converted referring to the following table.

Nominal tap voltage	Applicable voltage range	Fuse	Connector
100 V 110 V 120 V	90 - 110 V 99 - 121 V 108 - 132 V	0.5 A	Connect the power connector B to the "100 V SYSTEM" pins.
220 V 230 V 240 V	198 - 242 V 207 - 253 V 216 - 264 V	0.3 A	Connect the power connector B to the "200 V SYSTEM" pins.

8/2/16
29442530

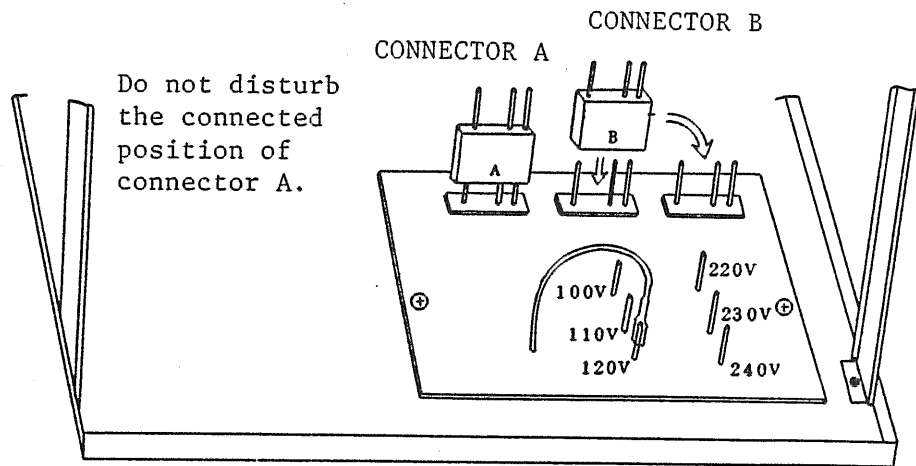

Connect the selector cord to the corresponding pin.

Fig. 4

Notes:

- o Before performing AC line conversion, ensure that the AC power cord is disconnected from the AC power line outlet.
- o Use a cord and a plug which meet the requirements of the line power to be used.
- o The linefilter capacitor is not required to be changed.

704424

4. OPERATING PROCEDURE

4.1 Preliminary Procedure (See Fig. 1)

Before turning-on the oscilloscope power, set the knobs on the front panel as shown in the following table:

Item	No.	Setting
POWER	①	OFF position
INTEN	②	Mid-position
FOCUS	⑤	Mid-position
MODE	⑫	Press CHL button ⑫
↕ POSITION	⑧ ⑬	Mid-position
VOLTS/DIV	⑭ ⑯	GND position
VARIABLE	⑮ ⑰	↙ CAL position
AC - DC	⑳ ㉑	⏏ AC position
H, V	⑨	⏏ V position
TIME/DIV	㉓	1 mS/DIV position
VARIABLE	㉔	↙ CAL position
TRIGGERING	㉖ ㉗ ㉘	Press CHL button ㉘ .
↔ POSITION	㉙	Mid-position

794425

Connect the power cord to an AC line outlet of the correct voltage and, then proceed as follows:

- 1) Turn the POWER switch (1) from the OFF position to the ON position. A click sound (power-on sound) is generated and the LED light turns-on at an upper left of the knob.
- 2) In about 10 seconds after the above, a bold horizontal trace line will be displayed on the CRT screen. Adjust the trace to an appropriate brightness with the INTEN knob (2).

If no trace is displayed within about 20 seconds, repeat setting of each knob as indicated in the above table.

- 3) Connect the signal of the CALIB (0.5 Vp-p) terminal to the vertical INPUT terminal (18) using the 942A Terminal Adaptor supplied.
- 4) Set the VOLTS/DIV switch (14) in the 0.1 V position, so adjust the VARIABLE knob (15) that the displayed signal amplitude becomes 2 DIV, and make the displayed waveform stationary by turning the LEVEL knob (25). When this is done, a waveform as shown in Fig. 5 will be displayed on the CRT screen.

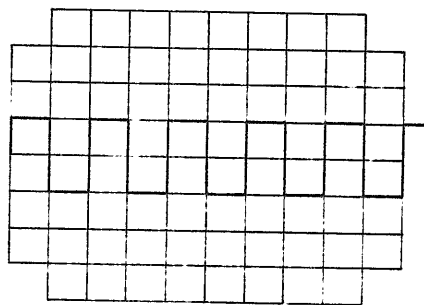

Fig. 5

704426

- 5) So adjust the FOCUS knob (5) that the displayed waveform becomes sharpest.
- 6) So adjust the VOLTS/DIV switch (14) and TIME/DIV switch (23) that an appropriate number of peaks are displayed with an appropriate amplitude.
- 7) Align the displayed waveform with the graticule by adjusting the vertical POSITION knob (13) and horizontal POSITION knob (29), and determine the voltage (V) and period (T).

The above explanation is for the single-channel operation with CHL. The same explanation is applicable for the single-channel operation with CHR, simply by replacing "CHL" with "CHR". For the single channel operation with CHR, press the NORM button (27) of TRIGGERING selector or set it in the CHL + CHR state (press the CHL button (28) and NORM button (27) at the same time). The dual-channel operation and general operation methods of the oscilloscope are explained in the subsequent sub-sections.

4.2 Dual-trace Operation (STEREO operation)

Press the CHL button (12) and CHR button (11) of MODE selector at the same time to set the oscilloscope in the STEREO state. When this is done, another trace will be displayed on the CRT screen. This trace is of CHR. (The trace explained in the preceding sub-section is of CHL.) At this state of procedure, the CHL trace is the square wave of the calibration signal and the CHR trace is a straight line as no signal is applied to this axis yet.

Next, apply the calibration signal also to the CHR input terminal (19) in the same manner as done for the CHL channel, set the VOLTS/DIV switch (16) in the 0.1 V position, and so

794427

adjust the VARIABLE knob (24) and adjusting the vertical POSITION knobs (8) and (13) that dual traces as shown in Fig. 6 are displayed on the CRT screen.

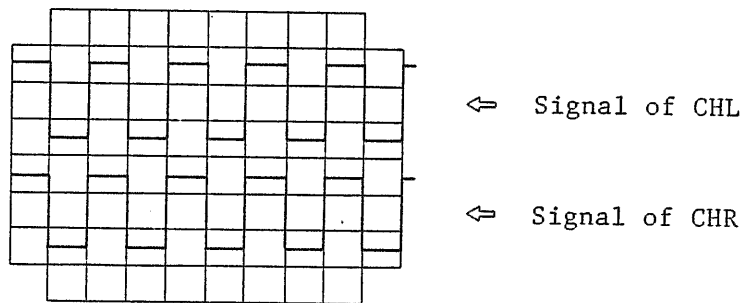

Fig. 6

When in the above state, by changing the MODE switch (9) from the V state to the H state and adjusting the vertical POSITION knobs (8) and (13), the signal waveforms of the CHL and CHR channels can be displayed to the left and to the right, respectively, on the same horizontal line as shown in Fig. 7. This is the horizontal STEREO operation.

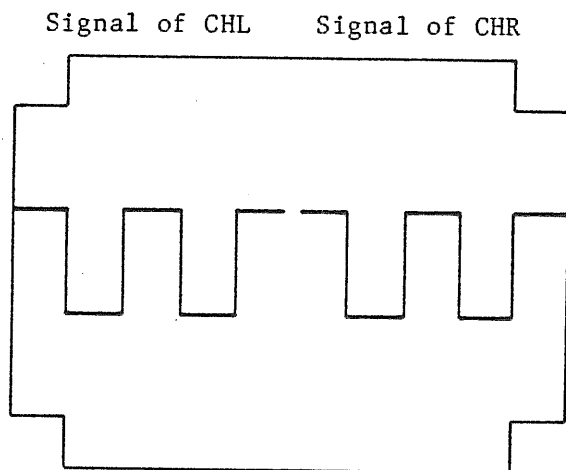

Fig. 7

794428

When in the STEREO operation, select a suitable triggering mode according to measurement -- amplitude measurement, phase measurement, etc. For amplitude measurement, set the TRIGGERING selector in the CHL + CHR state (press the CHL button (28) and NORM button (27) at the same time); for phase measurement, set the TRIGGERING selector in the CHL state (press the CHL button (28)).

When signals of mutually different frequencies are applied to the CHL and CHR channels, set the TRIGGERING selector in the NORM state (press the NORM button (27)).

This oscilloscope has eliminated the selector switch between CHOP and ALT modes for dual-trace operation. The sweep modes are switched being linked to the TIME/DIV switch (23). At the ranges the sweep speed is 1 msec/DIV or slower, switching is done in the CHOP mode; at the ranges the sweep speed is 100 μ sec/DIV or faster, switching is done in the ALT mode. When the TRIGGERING selector is set in the NORM state (27), switching operation in the ALT mode irrespective of setting of the TIME/DIV switch.

4.3 X-Y Operation

Set the MODE switch in the X-Y state (10). With this simple procedure, the instrument operates as an X-Y scope with CHL for X-axis and CHR for Y-axis.

For the Y-axis, the CHR operates in the same electrical performances and procedure. Regarding the X-axis, the frequency response becomes DC - 1 MHz (-3 dB) and the horizontal POSITION control (29) becomes effective for the X-axis while the CHL POSITION control (13) remains idle. Other electrical performance and procedure remain the same.

794429

Apply the calibration voltage signal to both X and Y axis and adjust the VOLTS/DIV knobs of individual axis so that a Lissajous figure as shown in Fig. 8 is displayed on the CRT screen.

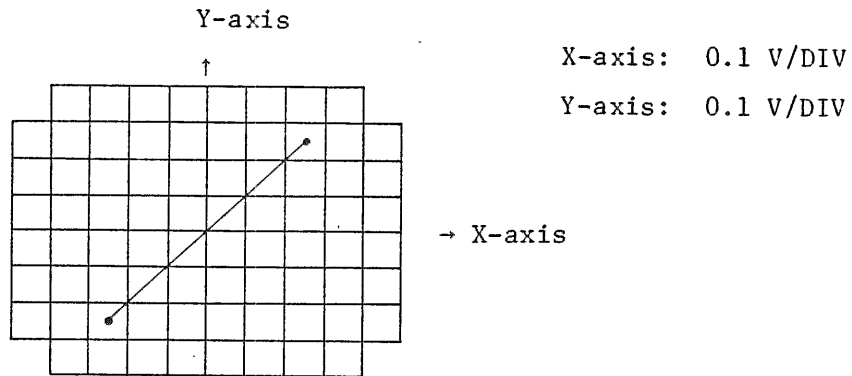

Fig. 8

Note: For measurement of high frequencies in the X-Y operation, pay attention to the frequency response and phase difference between X-axis and Y-axis of the oscilloscope itself.

794430

5. METHODS OF MEASUREMENTS

5.1 Connection Method of Input Signal

The input impedance of the oscilloscope as viewed from the vertical input terminal is $1\text{ M}\Omega$ with capacitance approximately 30 pF in parallel. When the probe (option) is used, the impedance increases to resistance $10\text{ M}\Omega$ with capacitance approximately 12 pF in parallel.

There are various methods of connection between measured signal source and oscilloscope. The most popular methods are with regular wires, with shielded wires, with a probe, or with a coaxial cable. Suitable ones are used taking the following factors into consideration.

Output impedance of input signal source

Level and frequency of input signal

External induction

Distance between input signal source and oscilloscope

Types of input signals and connection methods are tabulated in the following:

794431

Type of input signal \ Connection method			General wire	Shielded wire	Probe	Coaxial cable	Others
Low frequency	Low impedance	Near	○	○	○	○	
		Far		○		○	
	High impedance	Near		⊗	○	⊗	
		Far		⊗		⊗	
High frequency	Low impedance	Near			○	○	
		Far				○	
	High impedance	Near			○	⊗	
		Far					

(○: Good, ⊗: Fair)

o Connection with regular wires:

Set 942A Type Adaptor to the vertical input terminal and connect regular wires to the adaptor. This method is simple and the input signal is not attenuated. However it susceptible to induction noise when long wires are used or when the signal source impedance is high. Another disadvantage is a large stray capacity with respect to the ground. As compared with the case the 10 : 1 probe (option) is used, larger effects are caused by the stray capacity.

o Connection with shielded wire:

The use of a shielded wire prevents external induction noise. However, the shielded wire has as large stray capacitance as 50 pF/m - 100 pF/m and this method is not suitable when the signal source impedance is high or the measured signal frequency is high.

794432

- o Connection with coaxial cable:

When the output impedance of the signal source is 50Ω or 75Ω , the input signal can be fed without attenuation up to high frequencies by using a coaxial cable which enables impedance matching. For impedance matching, terminate the coaxial cable with a 50Ω or 75Ω pure-resistive resistor corresponding to the characteristic impedance of the coaxial cable, as shown in Fig. 9.

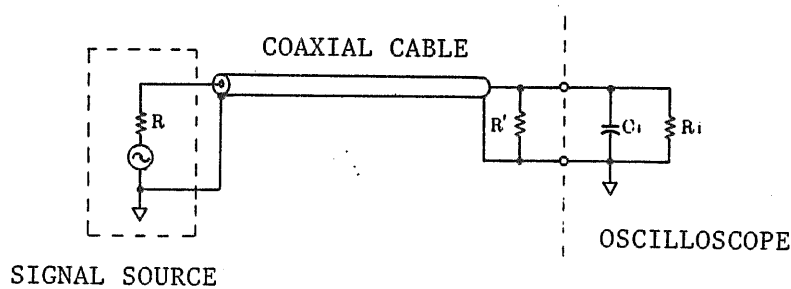

$$R = R'$$

When $R = 50 \Omega$, use a 50Ω coaxial cable.

When $R = 75 \Omega$, use a 75Ω coaxial cable.

Fig. 9

- o Connection with probe:

A probe (example: 960 BNC Type Probe) with an attenuation ratio of 10 : 1 is available as an option. The probe circuit and probe cable are shielded to prevent induction noise. The probe circuit makes up a wide-range attenuator in conjunction with the input circuit of the oscilloscope, thereby enabling a distortionless connection from DC to high frequencies. Then the probe is used, although the signal level is attenuated to 1/10, the input impedance

becomes very high (resistance 10 MΩ, capacitance approx. 20 pF) and the loading effect on the measured signal source is greatly reduced as explained in the following:

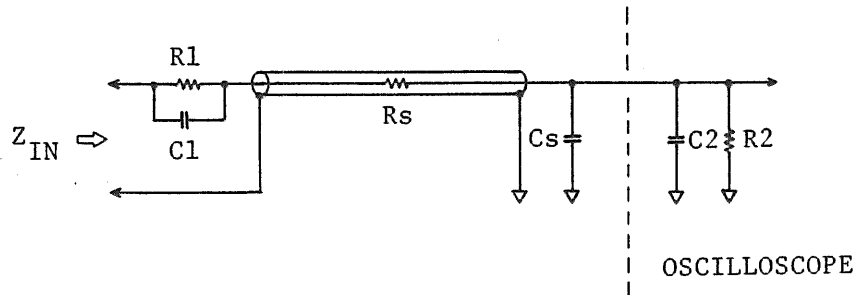

R_s = Series resistance of cable

C_s = Stray capacitance + cable capacitance

Fig. 10

The probe makes up a wide-range attenuator with its resistor R_1 which make up an attenuator circuit with respect to input resistor R_2 of the oscilloscope and with its capacitor C_1 which compensates for input capacitor C_2 of the oscilloscope and stray capacitance (C_s) of the cable. The input impedance Z_{IN} is expressed as follows:

$$Z_{IN} = \frac{R_1 + R_2}{C (R_1 + R_2) + 1}$$

$$C = \frac{C_1 (C_2 + C_s)}{C_1 + C_2 + C_s}$$

Attenuation factor A is expressed as follows:

$$A = \frac{R_2}{R_1 + R_2} \quad \left(= \frac{1 \text{ M}\Omega}{9\text{M}\Omega + 1\text{M}\Omega} = \frac{1}{10} \right)$$

Precautions:

- o Observe the maximum allowable input voltages mentioned in Item 3.4 "Precautions in Operation."
- o Be sure to use the ground lead wire which accompanies the probe. When used in the dual-channel mode also, be sure to use the ground lead wires for individual channels.
- o Before commencing measurement, accurately adjust the phase of the probe without fail.
- o Do not apply unreasonably large mechanical shocks or vibration to the probe. Do not sharply bend or strongly pull the probe cable.
- o The probe unit and tip are not highly heat resistant. Do not apply a soldering iron to a circuit close to the point where the probe is left hooked up.

5.2 Voltage Measurement

To measure an AC signal which has no DC component or to measure the AC component alone of a signal which has a DC component superimposed on the AC component, set the vertical input AC/DC selector switch (20 , 21) in the AC position. To measure a signal which has a DC component, set the switch in the DC position.

Before commencing voltage measurement, set the VARIABLE attenuator knob (15 , 17) to the CAL position and calibrate the sensitivity to the value indicated by the VOLTS/DIV selector (14 , 16).

Apply the signal to be measured, display the signal with an appropriate amplitude on the screen, and determine the amplitude on the graticule. (For DC voltage measurement, determine the shifted distance of the trace.) The voltage can be known as follows:

- (1) When measured signal is directly applied to input terminal:

$$\text{Voltage (V)} = \text{Deflection amplitude (DIV)} \times \text{Indication of VOLTS/DIV switch}$$

- (2) When the 10 : 1 probe is used:

$$\text{Voltage (V)} = \text{Deflection amplitude (DIV)} \times \text{Indication of VOLTS/DIV switch} \times 10$$

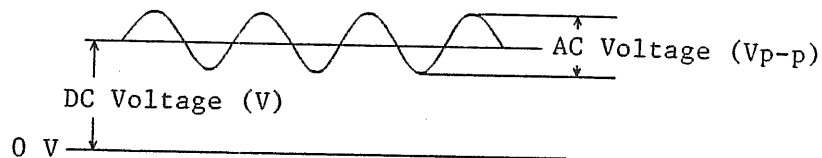

Fig. 11

- (3) Comparison of amplitudes of CHL and CHR:

To compare the amplitudes of CHL and CHR, set the MODE switch (9) in the H state for the horizontal dual-trace operation and adjust the sweep at an appropriate speed. Denoting the amplitudes of CHL and CHR by A (DIV) and B (DIV) as shown in Fig. 12, the differential amplitude is calculated as follows:

$$\text{Differential amplitude (dB)} = 20 \log \frac{B}{A}$$

794436

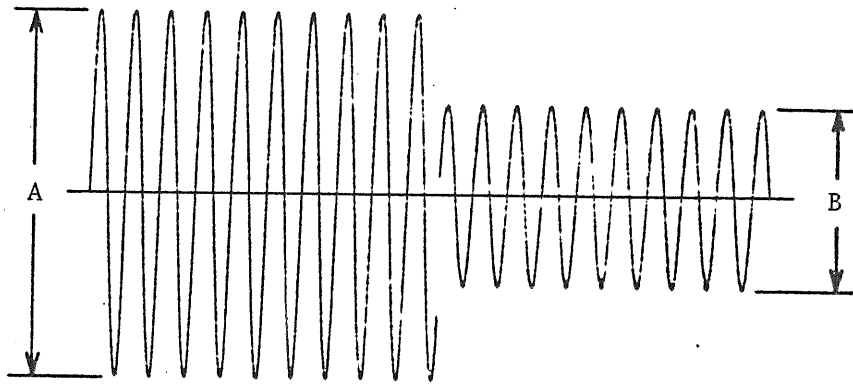

Fig. 12

5.3 Current Measurement (Voltage Drop Method)

Connect a small-resistance resistor (R) in series in the circuit in which the current (I) to be measured flows and measure the voltage drop across the resistor with the oscilloscope. The current is known from Ohm's Law as follows:

$$I = \frac{E}{R} \quad (A)$$

The resistance should be as small as that it does not cause any change to the measured signal source.

In the above method, currents from DC to high frequencies can be measured quite accurately.

5.4 Time Measurement

Measurement of time interval

The time interval between any two points on the displayed waveform can be measured by setting the TIME/DIV VARIABLE knob (24) in the CAL position and referring to the indication of the TIME/DIV switch (23).

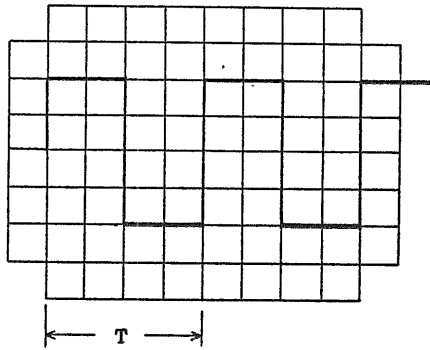

Fig. 13

$$\text{Time T (sec)} = \text{Indication of TIME/DIV} \times \text{Horizontal span (DIV)}$$

5.5 Frequency Measurement

- o Frequency measurement by determining time (T) per one cycle of the displayed waveform:

Time T (period) is measured as explained in Item 5.4 and the frequency is calculated by using the following formula.

$$\text{Frequency } f \text{ (Hz)} = \frac{1}{\text{Period T (sec)}}$$

- o Frequency measurement with Lissajous figure (See Figs. 14 and 15.):

Set the MODE switch in the X-Y state so that the instrument operates as an X-Y scope. (See Item 4.3 "X-Y Operation.")

Apply to the X-axis a known frequency from a signal generator (SG) and to the Y-axis the frequency to be measured. So adjust the required controls that a pattern is displayed on the overall surface of the CRT screen. Then so adjust the frequency of the

signal generator that the displayed pattern becomes stationary as shown in Fig. 14. From the displayed waveform, the unknown frequency can be calculated as follows:

$$\text{Unknown frequency (Hz)} = \frac{\text{The number of crossing points over horizontal scale line}}{\text{The number of crossing points over vertical scale line}} \times \text{Frequency of signal generator (Hz)}$$

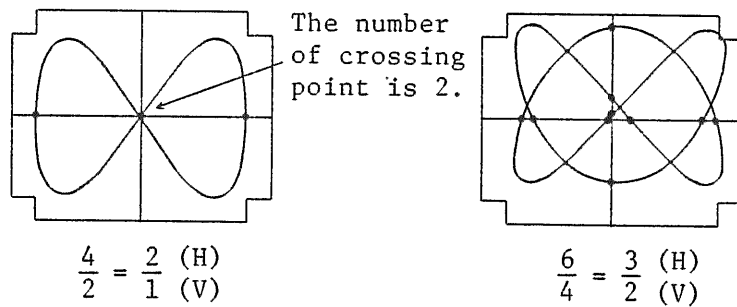

Fig. 14

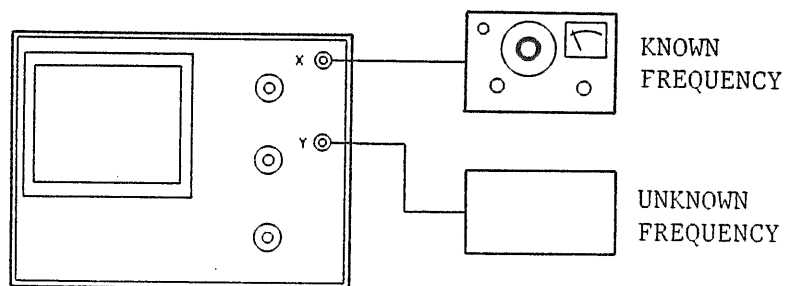

Fig. 15

794439

5.6 Measurement of Phase Difference

o Measurement with dual-trace operation (1):

Set the oscilloscope in the horizontal dual-trace STEREO mode by pressing the CHL (12) and CHR (11) buttons of the MODE switch at the same time and setting button (9) in the H state. Set the TRIGGERING selector in the CHL state (press button (28)), and apply the signal which is used as reference to the CHL input terminal (18) and the signal which is to be measured to the CHR input terminal (19). Make equal the amplitudes of the CHL and CHR channels by adjusting the VOLTS/DIV switches (14) and (16) and VARIABLE knobs (15) and (17). Align the vertical positions of the two signals by adjusting the vertical POSITION knobs (8) and (13).

Determine the vertical distance between reference signal and measured signal and denote the distance by B (DIV) as shown in Fig. 16. Also determine the signal amplitude and denote it by A (DIV). The phase difference (α) can be calculated with the following equation:

$$\alpha (^{\circ}) = \frac{A}{B} \times (\pm 180^{\circ})$$

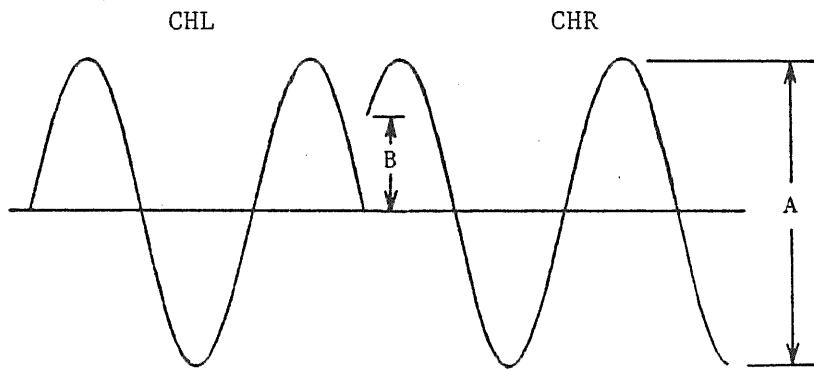

Fig. 16

794440

o Measurement with dual-trace operation (2):

Set the oscilloscope in the horizontal dual-trace STEREO mode as in the above measurement (1), and set the TRIGGERING selector in the CHL state (press button (28)). Apply the reference signal to the CHL input terminal (18) and the measured signal to the CHR input terminal (19). Determine the distances from the junction point of the two signals to the points where the two signals cross the horizontal base line and denote them by A (DIV) for CHL and B (DIV) for CHR as shown in Fig. 17. Denoting one cycle period of the signal by T (DIV), the phase difference can be calculated with the following equation:

$$\alpha (^{\circ}) = \frac{A - B}{T} \times 360^{\circ}$$

Where, if $A < B$, the measured signal is in a leading phase; if $A > B$, the measured signal is in a lagging phase; and if $A = B$ the two signals are in the same phase.

For this measurement the displayed amplitudes of the two signals are not required to be made equal. The only requirement is that they are easily measurable. However, their zero levels must be accurately aligned.

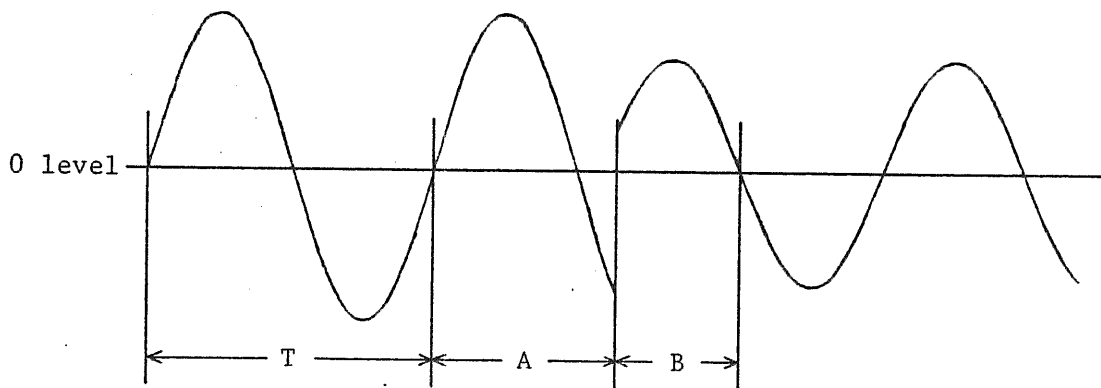

Fig. 17

o Measurement with dual-trace operation (3):

Set the TRIGGERING selector in the CHL mode (press button (28)), apply the reference signal to the CHL input terminal (18) and the measured signal to the CHR input terminal (19), and set the MODE switch button (9) in the V_u state in order that the oscilloscope operates in the vertical dual-trace mode.

Determine distance A (DIV) between the points where the two signal cross the base line as shown in Fig. 18. Denoting one cycle period of the CHL signal by T (DIV), the phase difference can be calculated with the following equation:

$$\alpha (^{\circ}) = \frac{A}{T} \times 360^{\circ}$$

If A is in the left hand side of the measuring point of the reference signal, the measured signal is in a leading phase; if it is in the right hand side, the measured signal is in a lagging phase.

For this measurement the displayed amplitudes of the two signals are not required to be made the same, although it is recommendable to align the zero levels of the signals with the graticule lines for ease of measurement.

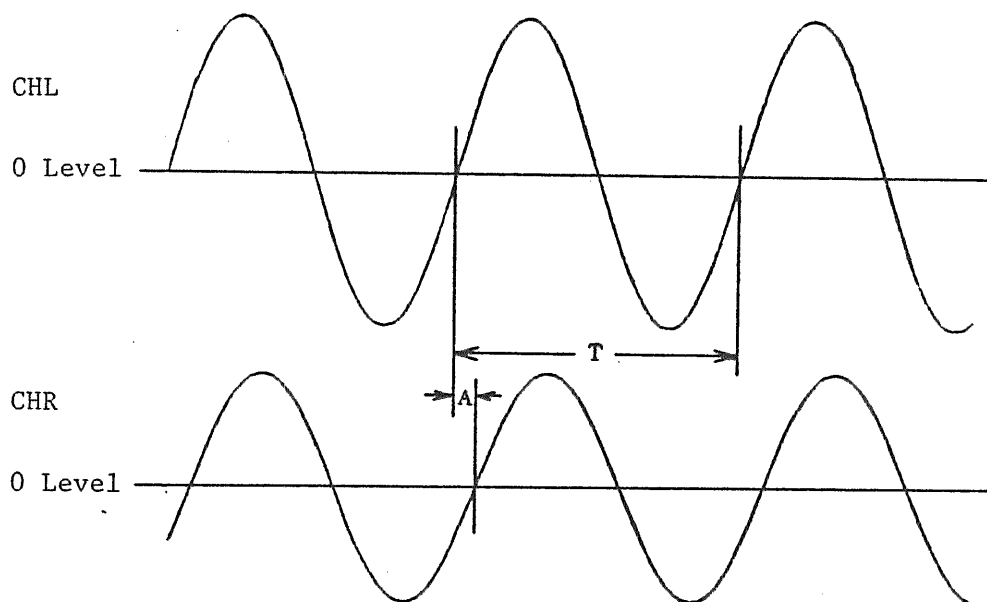

Fig.18

o Measurement with Lissajous figure:

Set the oscilloscope in the X-Y mode by pressing the X-Y button (10) of the MODE selector. Apply two signals of the same frequency (such as stereophonic signals) to the X-axis input terminal (18) and Y-axis input terminal (19), and adjust equal the two signal amplitudes so that a Lissajous figure is displayed on the screen. Position the center of the Lissajous figure in the center of the screen, and determine distance A (DIV) between the two points where the Lissajous figure crosses the X-axis (or Y-axis) and determine amplitude B (DIV) of the Lissajous figure on the X-axis (or Y-axis). Phase difference α can be calculated by the following equation:

$$\sin \alpha = \frac{A}{B}$$

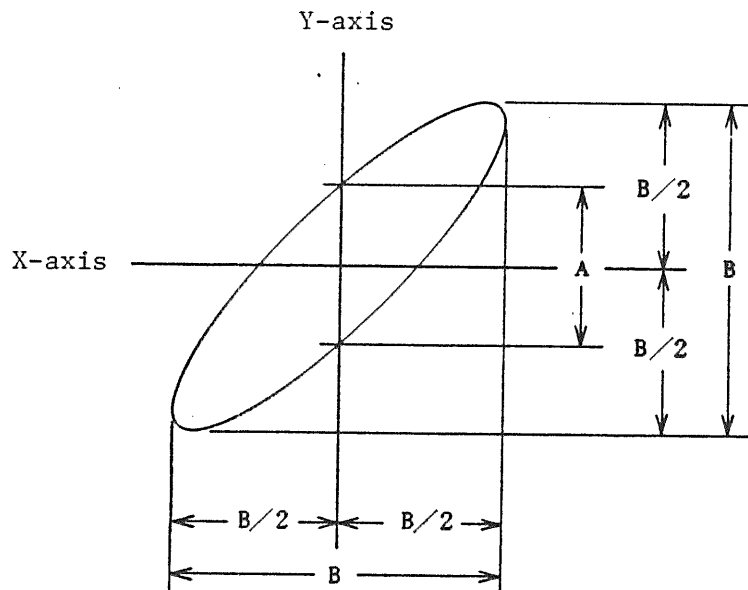

Fig. 19

For example, when the deflection amplitudes of the X-axis and Y-axis signals are set at 8 DIV, the phase difference can be known using Table 1 from the distance between the two points where the Lissajous figure crosses the X-axis (or Y-axis).

When the phase difference is within $0^\circ \pm 90^\circ$, the Lissajous figure is a slanted ellipse with its left side up; when the difference is within $180^\circ \pm 90^\circ$, the figure is a slanted ellipse with its right side up; when the difference is 90° or 270° , the figure is a circle; when the difference is 0° , the figure is a slanted line with its right side up; when the difference is 180° , the figure is a slanted line with its left side up.

Table 1

Distance (DIV) on X or Y axis	Phase difference ($^{\circ}$)
0	0
0.1	0.7
0.2	1.4
0.3	2.2
0.4	2.9
0.5	3.6
1.0	7.2
1.5	10.8
2.0	14.5
2.5	18.2
3.0	22.0
3.5	25.9
4.0	30.0
5.0	38.7
6.0	48.6
7.0	61.0
8.0	90.0

794445

Notes: The oscilloscope shipped from the factory is so set that, when it is operated in the horizontal dual-trace STEREO mode, the CHL signal is swept from the left end to the screen center and the CHR signal from the right end to the screen center. The user can change the sweep direction of the CHR signal so that the signal is swept from the screen center to the right end by setting of internal switch.

When the sweep direction has been changed as above, the phase difference measurement with dual-trace operation as described in Section 5.6 cannot be done because the sweep direction has been inverted by 180°.

To change the sweep direction, set the switch from "NORM" to "INV" on the pattern side of printed circuit board A1 as shown in Fig. 20.

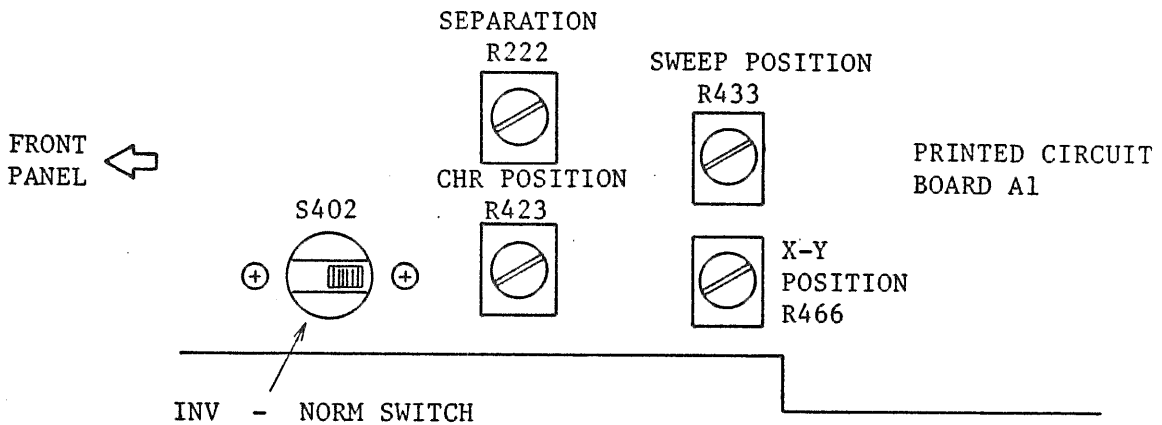

Fig. 20

5.7 Measurement of Pulse Waveform Characteristics

A theoretically ideal pulse waveform is such that the signal changes instantaneously from a certain level to another level, held in this level for a certain period, and returns instantaneously to the original level. However, actual pulse waves are distorted. Nomenclature of distortions is given in Fig. 21.

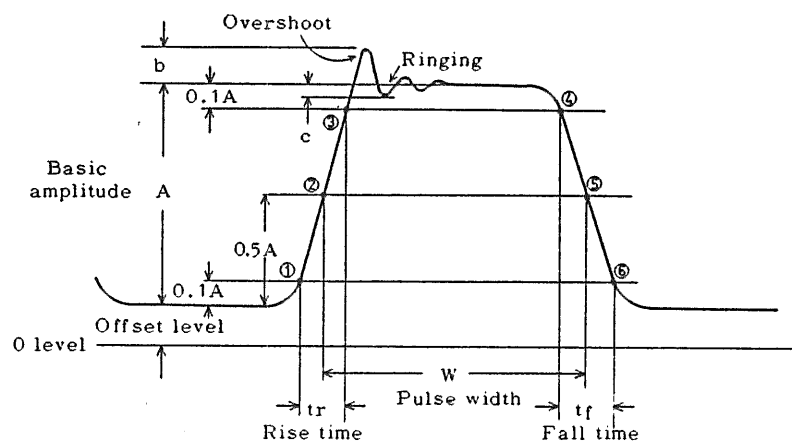

Fig. 21

Pulse amplitude: Basic amplitude (A) of pulse

Pulse width: Time between points ② and ⑤ where signal amplitude is 50% of basic amplitude

Rise time: Time between 10% basic amplitude point ① and 90% basic amplitude point ③

Fall time: Time between 90% basic amplitude point ④ and 10% basic amplitude point ⑥

Overshoot: Amplitude of the first maximum excursion beyond basic amplitude. Expressed in terms of $b/A \times 100$ (%)

794447

Ringings: Oscillation which follows the first maximum excursion. Expressed in terms of $c/A \times 100$ (%)

o Measurement of rise time:

The rise time of a pulse can be known by determining the value of t_r on the CRT screen in the method of "Time Measurement." It must be noted that t_r determined on the CRT screen includes the rise time of the oscilloscope itself. The closer the rise time of the oscilloscope (t_o) to the rise time of the measured pulse (t_n), the larger is the error introduced. To eliminate this error, calculation should be done as follows:

$$\text{True rise time } t_n = \sqrt{(t_r)^2 - (t_o)^2}$$

where, t_r : Rise time measured on CRT screen
 t_o : Rise time of oscilloscope itself
(approx. 70 nsec)

For example, when a pulse wave with rise time 210 nsec (about 3 times of that of the oscilloscope) is measured on the CRT screen, the error is approximately 6%.

o Measurement of Sag

Pulse waveforms may have slanted sections as shown in Fig. 22, other than those distortions mentioned in Fig. 21. (For example, slants are caused when the signal is amplified with an amplifier which has poor low-frequency characteristics, resulting from attenuation of the low frequency component.) The slanted section (d or d') is called "sag" which is calculated as follows:

$$\text{Sag} = \frac{d}{A} \quad (\text{or } \frac{d'}{A'}) \times 100 \text{ (\%)}$$

794448

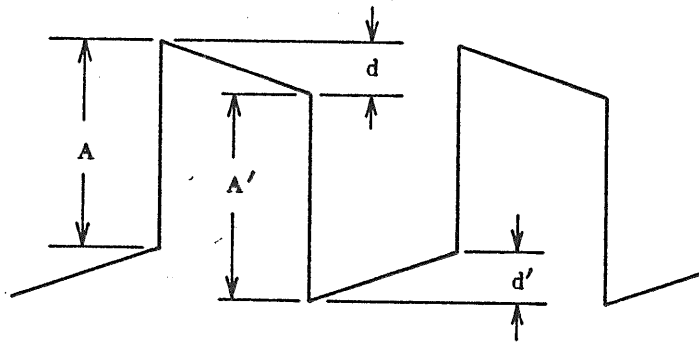

Fig. 22

Note: If the AC-coupling mode is used for measurement of a low frequency pulse, sags are caused. For measurement of low frequency pulses, use always the DC-coupling mode.

794449

6. CALIBRATION

6.1 General

The oscilloscope should be calibrated at certain time intervals. Although calibration of overall performances is most recommendable, such partial calibration may serve the purpose that the time axis alone is calibrated when the time measuring accuracy is especially important or that the vertical axis alone is calibrated when the vertical sensitivity accuracy is of prime importance. After the oscilloscope has been repaired, overall calibration is required although it depends on the type of repair. For the repair service, contact manufacturer's representative in your area.

6.2 Check and Adjustment of DC Power Supply

Before calibrating the oscilloscope, its DC supply voltages should be checked and adjusted. Check and adjust the +12V supply voltage first and the other supply voltages next. The supply voltages are shown in the following table, and the check and adjustment points are indicated in Fig. 24. For removing the case, refer to Fig. 23.

Nominal voltage	Voltage range	Check and adjustment points
+5V	+4.5 V - +5.5 V	TP-4
+12V	+11.95V - +12.05V	TP-1. Adjust the "+12VADJ"
-12V	-11.80V - -12.20V	TP-2
+200V	+180V - +230V	TP-3
-1500V	-1450V - -1550V	TP-5

70M450

For voltage check, measure the voltage between check point and ground using a reliable digital voltmeter. The +12V supply must be especially carefully adjusted because it provides a reference for other supplies. To measure the -1500V supply of which internal impedance is high, use a voltmeter of a high input impedance (10 M Ω or over).

Because adjustments of supply voltages largely affects vertical sensitivity and horizontal sweep time, the oscilloscope must be re-calibrated as explained in the subsequent paragraphs.

* Removing the case

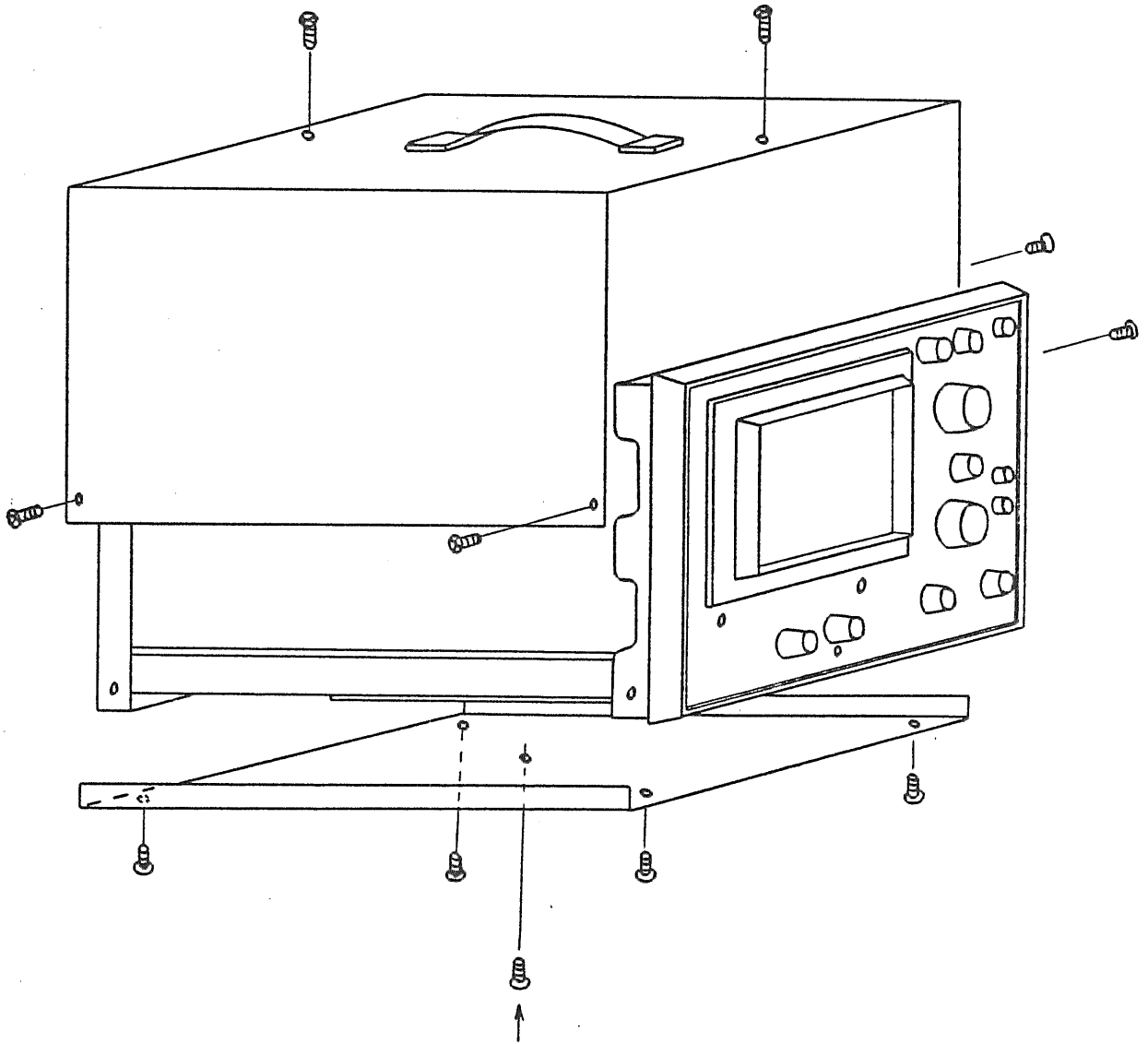

HANDLE ESPECIALLY CAREFULLY SINCE THIS
SCREW CLAMPS THE PRINTED BOARD.

Fig. 23

794452

As viewed from the bottom

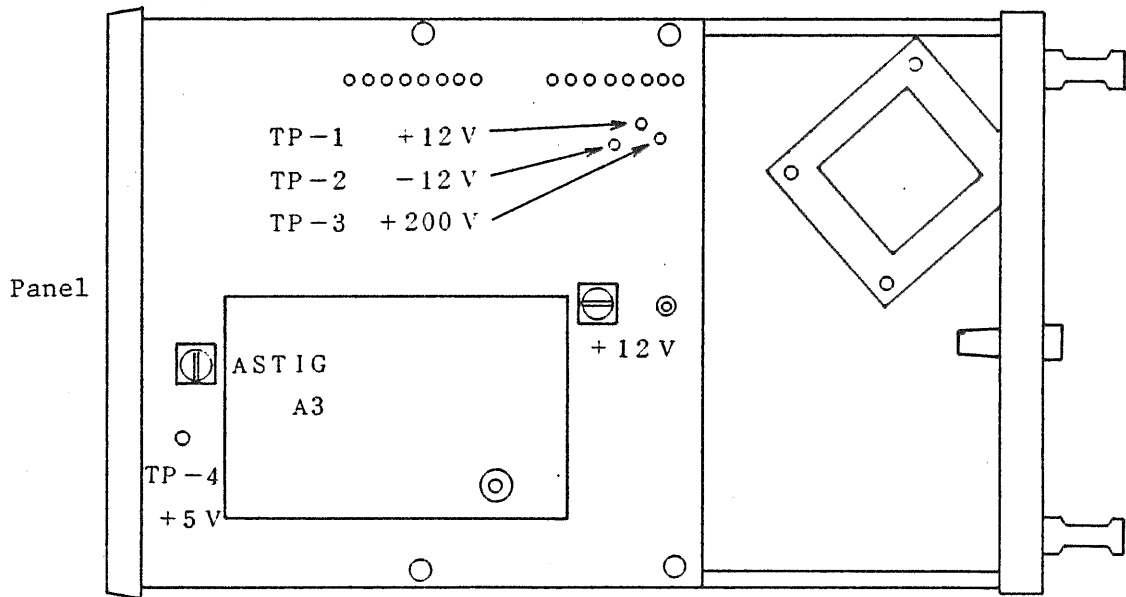

Fig. 24

As viewed from the left hand side

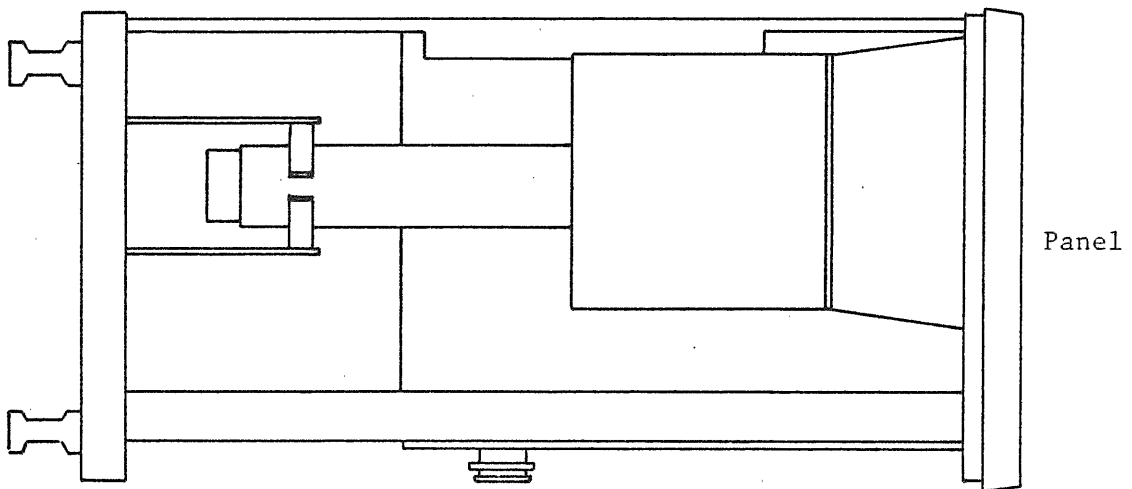

Fig. 25

794453

05/12/18

799266

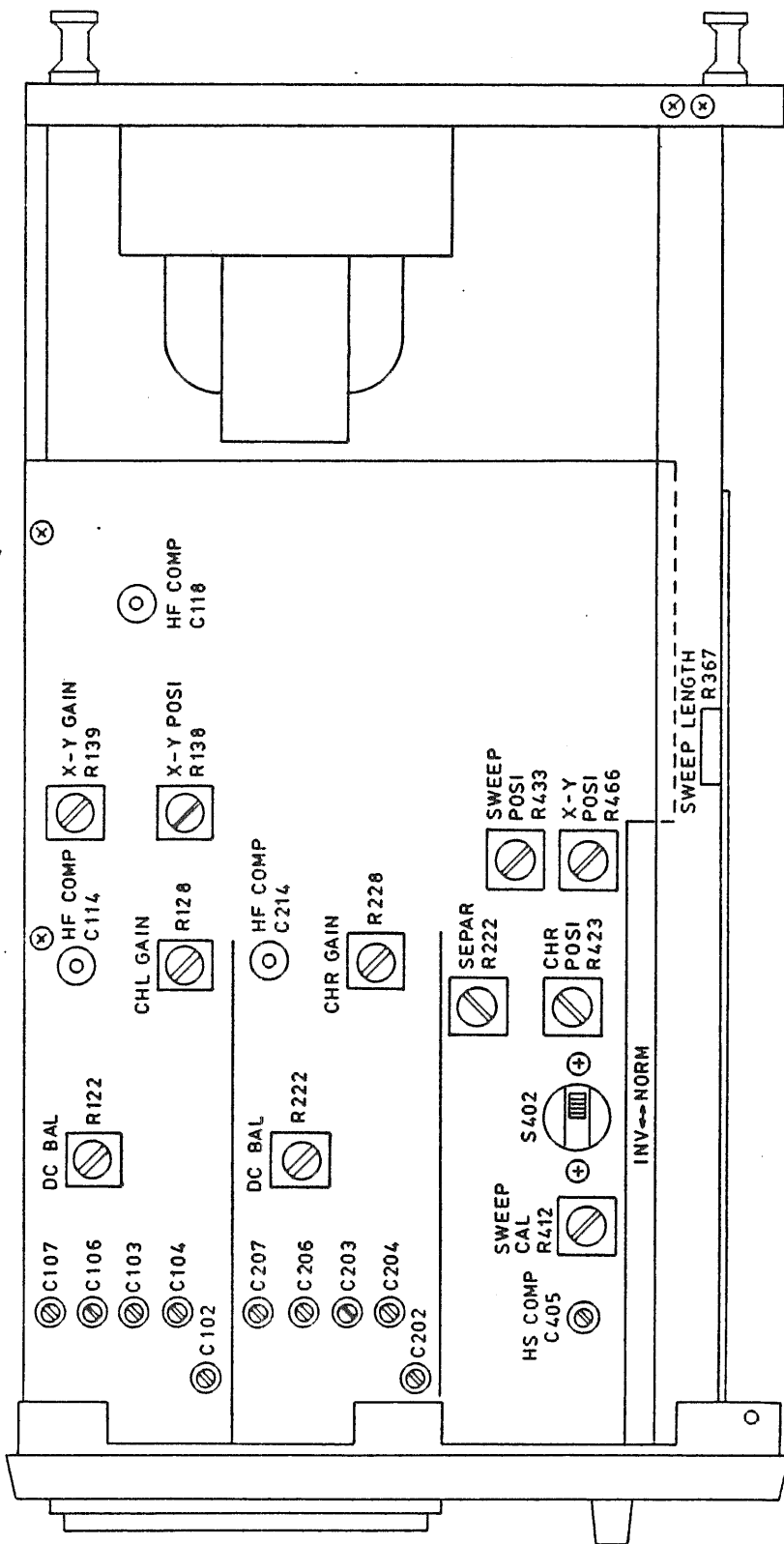

Fig. 26

6.3 Adjustment of Vertical Axis

o Adjustment of DC BAL

This control is for minimizing the shift of the trace when the VARIABLE KNOB is turned.

- (1) Set the VOLTS/DIV switch (14) or (16) in the GND range and display the trace on the CRT screen.
- (2) Turning the VARIABLE knob, so adjust the DC BAL control that the shift of the trace becomes minimum. (See Fig. 26)

o Calibration of sensitivity

This control is for adjusting the vertical gain so that the vertical deflection amplitude conforms with the value indicated by the VOLTS/DIV switch. For calibration, a pulse wave generator which can provide an output signal with a voltage setting accuracy of 0.5% or better at a frequency of 1 kHz should be used.

- (1) Set the pulse wave generator output at 80 mV and apply this signal to the vertical INPUT terminal.
- (2) Set the VARIABLE knob in the CAL position and the VOLTS/DIV switch in the 10 mV position, and so adjust the GAIN ADJ control (Fig. 26) that the deflection amplitude on the CRT screen becomes as set in 8 DIV.

When the above adjustment is made, other ranges also are automatically calibrated with an accuracy of $\pm 5\%$ or better.

- o Adjustment of input attenuator (input capacitance adjustment and phase compensation)

The VOLTS/DIV switch is a 1/10-step input attenuator. If the phase compensation of the input attenuator has been disturbed, the oscilloscope does not present the normal frequency response and the displayed waveform is distorted. If the input capacitance has been disturbed, the procedure of "Calibration of Probe" is required to be performed each time the range is changed. Refer to Item 5.1 "Connection Method of Input Signal", Para. "Connection with probe."

For phase characteristics adjustment, use a pulse generator which can provide a square wave which has no sags or overshoots or other distortions and which has a rise time of faster than 1 μ sec. Display this signal with an amplitude of 4 DIV at each range, and so adjust the phase compensation capacitor that the displayed square wave signal becomes the best waveform. For this adjustment, use a pulse repetition frequency of approximately 1 kHz.

For input capacitance adjustment, connect a low-range C-meter to the input terminal and so adjust the input capacitance compensation capacitor that the input capacitance at each range becomes 30 pF \pm 2 pF.

For the above adjustment, set the oscilloscope in the operating state. The capacitors for respective ranges are shown in the following table.

Range	CHL		CHR	
	Adjusting capacitor		Adjusting capacitor	
	Input capacitance	Phase compensation	Input capacitance	Phase compensation
10 mV	C102	-	C202	-
0.1 V	C104	C103	C204	C203
1 V	C107	C106	C207	C206

- o Adjustment of high frequency characteristics of vertical amplifier

Adjust the high frequency response characteristics of the vertical amplifier using a quality square-wave pulse signal of rise time 10 nsec or faster at pulse repetition frequencies 10 kHz and 100 kHz.

- (1) Apply the 10-kHz pulse signal to the input terminal, set the VOLTS/DIV switch at 10 mV and the TIME/DIV switch at 100 μ S, and so adjust the input signal amplitude that the signal is displayed with a deflection amplitude of 4 DIV on the CRT screen.
- (2) So adjust the HF COMP (C118) of the output circuit that the leading edge of the square wave becomes flat.
(See Figs. 26 and 27.)
- (3) Apply the 100-kHz pulse signal to the input terminal, set the TIME/DIV switch at 1 μ S, and so adjust the HF COMP (C114 for CHL or C214 for CHR) of the preamplifier that the leading edge of the square wave becomes flat.
(See Figs. 26 and 28.)

794457

By the above procedure, the 4-DIV square-wave pulse signal displayed on the CRT screen is adjusted to an ideal waveform.

Adjustment of HF COMP (C118) of output stage

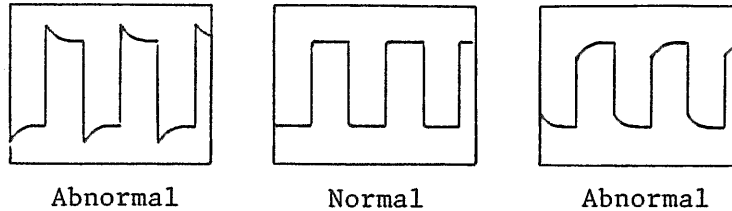

Fig. 27

Adjustment of HF COMP (C114, C214) of preamplifier

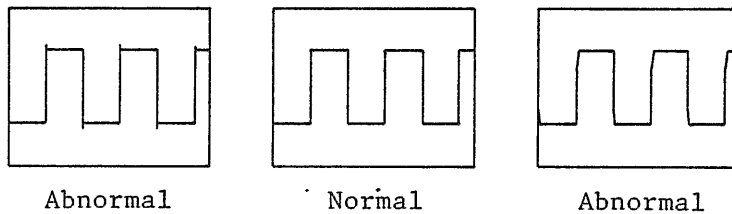

Fig. 28

6.4 Adjustment for Horizontal Dual-trace Operation

Set button ⑨ of the MODE switch in the H state and apply a sine wave signal of approximately 10 kHz to both CHL and CHR input terminals.

- o Adjustment when sweep directions are from both ends of screen toward center of screen:

This adjustment includes SWEEP POSITION adjustment, SEPARATION adjustment and SWEEP LENGTH adjustment. (See Fig. 26.)

3044448A

- (1) Set the horizontal POSITION knob (29) of Fig. 1 in a mid-position (the white dot of the knob set at the top position).
 - (2) Set the TIME/DIV switch (23) at the 100 μ S position.
 - (3) So adjust the SWEEP POSITION control that the CHL and CHR traces end at the center of the graticule.
 - (4) So adjust the SEPARATION control that the two traces start at the two ends on the graticule.
 - (5) So adjust the SWEEP LENGTH control that the ends of the CHL and CHR traces are spaced 0.2 DIV.
 - (6) Check again the SWEEP POSITION and SEPARATION adjustments.
 - (7) Apply a timer marker signal of 100 μ sec to the CHL and CHR input terminals.
 - (8) So adjust SWEEP CAL control (Fig. 26) that the periods of the displayed signal waveform conform with graticule lines. (See Section 6.5 Adjustment of Time base.)
- o Adjustment when sweep direction of CHL is from screen left end to screen center and that of CHR is from center to right end:

This adjustment includes CHR POSITION adjustment, and it must be done after the adjustment of the preceding section been done.

To change the sweep direction, set the switch from "NORM" to "INV" on the pattern side of printed circuit board A1 as shown in Fig. 29.

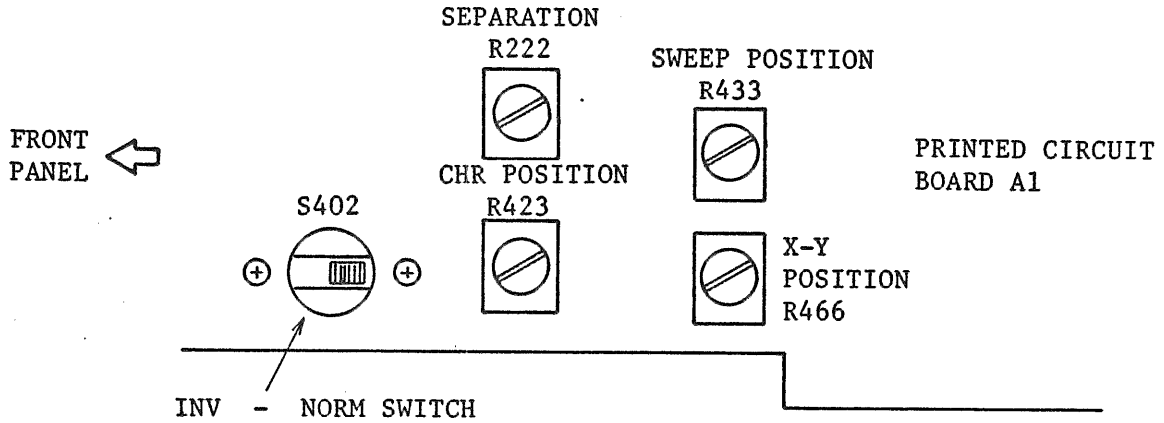

Fig. 29

- (1) After the switch is set as required, apply a time marker signal of 100 μ sec to the CHL and CHR input terminals and set the TIME/DIV switch at the 100 μ S position.
- (2) When the starting position of the CHL sweep is deviated from the left end of the graticule, adjust the starting position to the end of the graticule by adjusting the horizontal POSITION knob.
- (3) So adjust the CHR POSITION control that the starting position of the CHR sweep is set at the center of the screen. When this is done, the distance between the end of CHL sweep and the start of CHR sweep should be approximately 0.2 DIV.

104466
 104466
 104466

6.5 Adjustment of Time Base

This adjustment is for adjusting the actual sweep time of the trace to the value indicated by the TIME/DIV switch. For this adjustment, accurate time marker signals of repetition periods 100 μ sec and 1 μ sec or sine wave signals of frequencies 10 kHz and 1 MHz are required. When this adjustment is done, set the MODE switch (9) in the V_u mode (vertical dual-trace mode) and keep the VARIABLE knob in the CAL position.

- (1) Set the TIME/DIV switch at the 100 μ S position, apply a time marker signal of repetition period 100 μ sec or a sine wave signal of frequency 10 kHz to the vertical input terminal, and so adjust the input signal amplitude or the oscilloscope sensitivity that the signal is displayed with an appropriate deflection amplitude on the CRT screen.
- (2) So adjust the SWEEP CAL control (Fig. 26) that the periods of the displayed waveform conform with graticule lines.
- (3) Next, apply a 1- μ sec time marker signal or a 1-MHz sine wave signal to the vertical input terminal signal and set the TIME/DIV switch at the 1 μ S position.
- (4) So adjust the HS COMP control (Fig. 26) that the displayed waveform periods conform with graticule lines.
- (5) Check again for the 100 μ S range as Step (1) above.

By the above procedure, the sweep periods of the other ranges of the TIME/DIV switch also are calibrated to an accuracy of $\pm 5\%$ or better. (Fig. 30)

794461

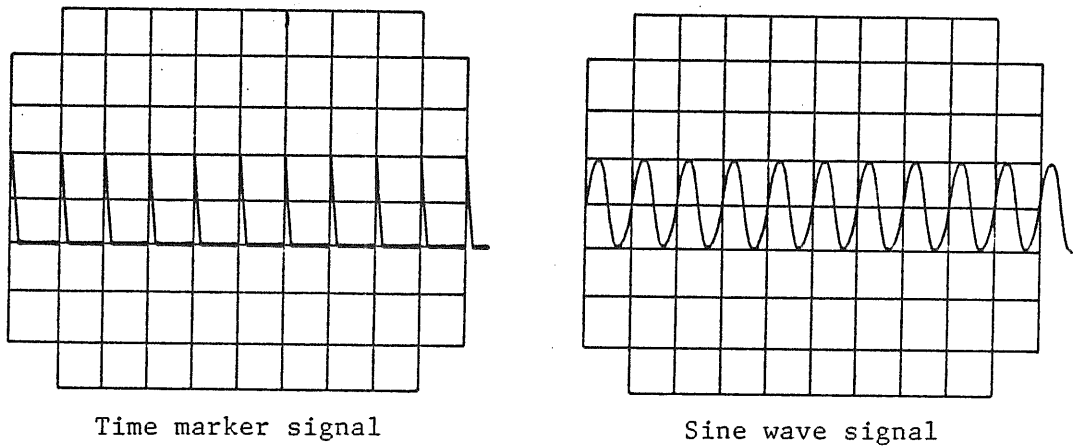

Fig. 30

6.6 Adjustment of X-axis

This procedure is for positioning of the X-axis and calibration of the X-axis when in the X-Y operation.

o X-axis positioning when in X-Y operation

- (1) For both CHL and CHR, set the VOLTS/DIV switch in the GND range and so set the horizontal POSITION knobs (29) that their white dot marks are positioned in the upright position (noon high position).
- (2) Set the vertical MODE switch in the X-Y state (10), and so adjust the X-Y POSITION (Semi-fixed resistor, see Fig. 26) that the spot is displayed on the center line of the graticule.

794462

- o X-axis sensitivity calibration when in X-Y operation:

The vertical sensitivities of CHL and CHR are calibrated in Section 6.3. (For the X-Y operation, the X-axis sensitivity is required to be calibrated while Y-axis is not required to be calibrated because its vertical sensitivity has already been calibrated.) For calibrating the X-axis sensitivity, use the signal generator which has been used in Section 6.3 "Adjustment of Vertical Axis."

- (1) Set the oscillator output signal at 100 mVp-p and apply this signal to the X-axis input terminal.
- (2) So adjust the X-Y GAIN control (Fig. 26) that the signal deflection amplitude becomes the full scale of the graticule.

6.7 Calibration of Probe (option)

As explained in Section 5.1, the probe makes up a kind of wide-range attenuator. Unless phase compensation is properly done, the displayed waveform is distorted causing measurement errors. Therefore, the probe must be properly calibrated before use. For probe calibration, use the signal of the calibration voltage output (CALIB, 0.5 Vp-p) terminal (6) of the front panel. (Fig. 31)

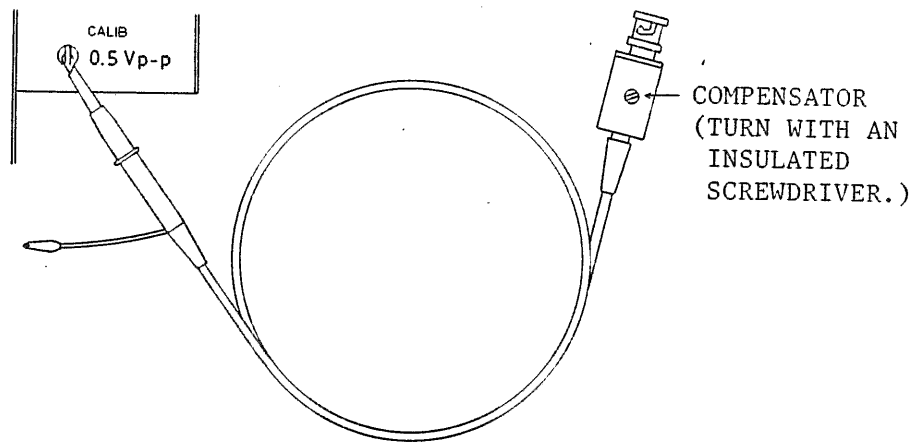

Fig. 31

Connect the probe cord to the INPUT terminal of CHL or CHR and set VOLTS/DIV switch in the 0.1 V position. Connect the probe tip to the calibration voltage output terminal and so adjust the COMPENSATOR control with an insulated screwdriver that an ideal waveform as illustrated below is obtained.

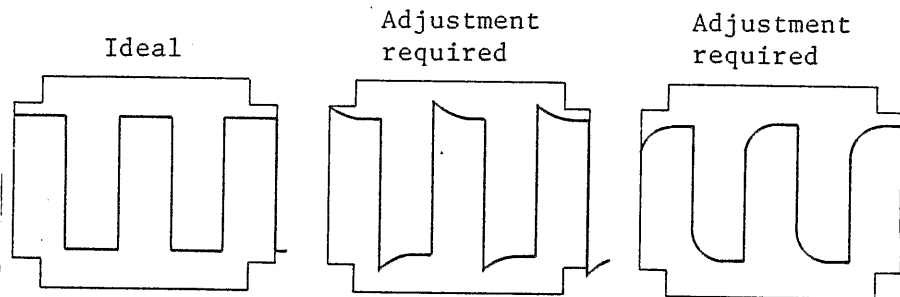

Fig. 32

794464

794465

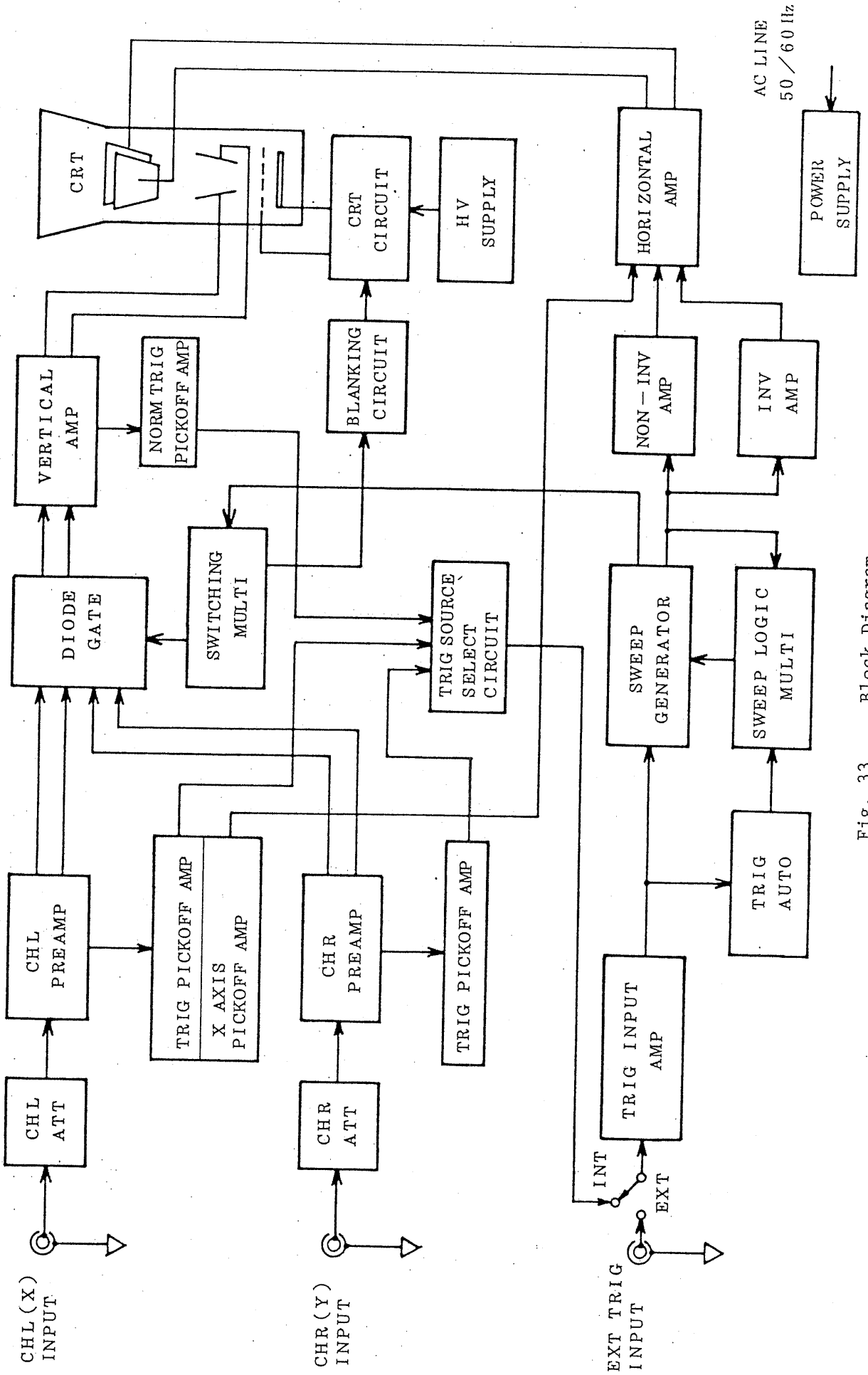

Fig. 33 Block Diagram